

Data Sheet

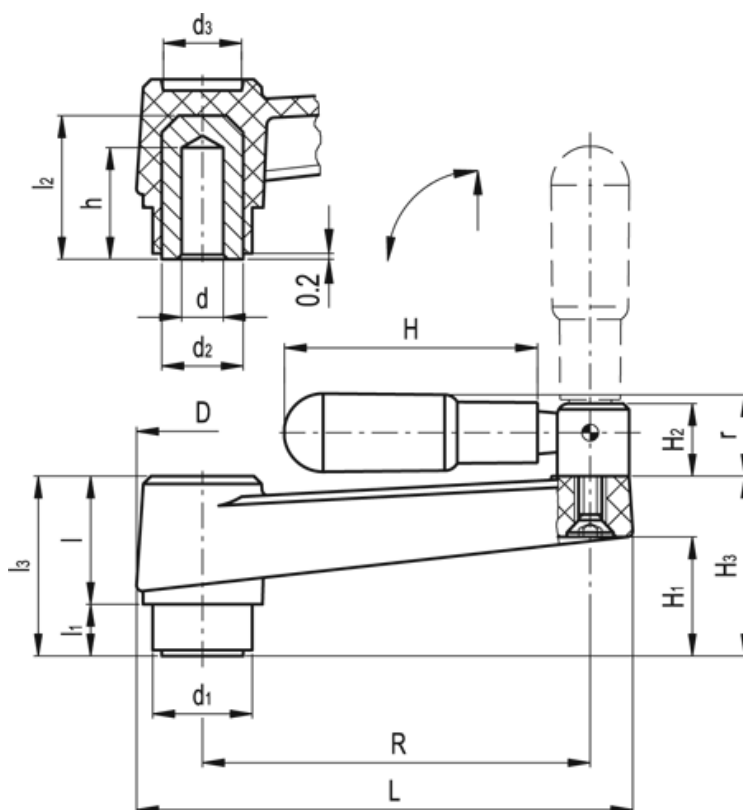

Article number: 2301044217
Description: E+G Crank handle
MT.80-AT+IR

Measures



D = 30	H2 = 14	r = 16.5
d1 = 23.5	H3 = 37.0	Weight (g) = 122
d2 = 18	L = 105	
d3 = 17	l = 26	
d H7 = 10	l1 = 10	
H = 60	l2 = 31	
h = 25	l3 = 36	
H1 = 23.0	R = 80	